



KABD-430 User Guide

The new Dayton Audio KABD series of boards leverages the convenience of Bluetooth 5.0 with aptX HD streaming along with the powerful Analog Devices ADAU1701 DSP chip to allow for almost limitless possibilities for sound customization and still have the convenience of high-quality Bluetooth streaming. Out of the box, basic customizations and volume control can be made by attaching the optional potentiometers, but to unlock the full potential of your amplifier, attach an ICP1 or KPX programming board to program your KABD amplifier with the SigmaStudio development tool from Analog Devices. This allows for limitless possibilities of EQ, limiting, bass enhancement, delays and more.

This guide applies to the KABD-430, which is a configurable 4 channel amplifier capable of multiple output modes. 4 x 30 Watts (4CH), 2 x 30 Watts + 1 x 60 Watts(2.1CH), or 2 x 60 Watts (2CH).

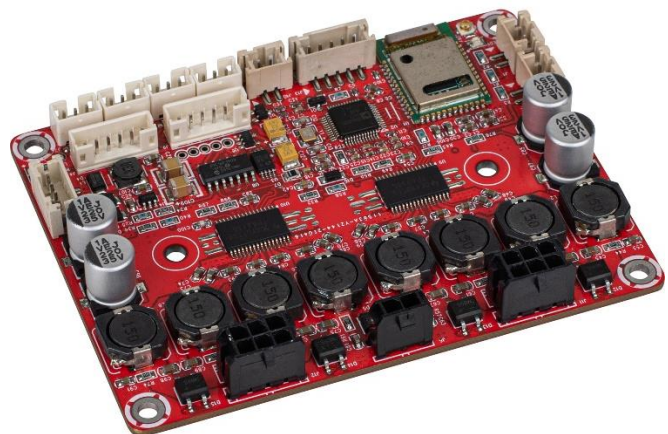
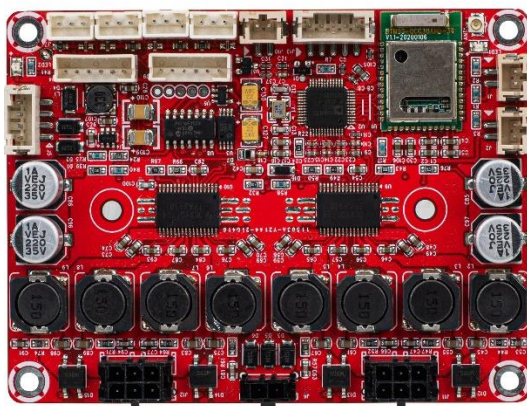

Table of Contents

KABD-430 Visual Overview	4
Quick Start and Wiring Guide	5
Before You Start	5
Power Supplies.....	5
Input Devices.....	5
Speaker Outputs	6
Quick Start Steps.....	7
Potentiometer Headers	12
Potentiometer Port Configuration in SigmaStudio.....	13
Using the Potentiometer Ports for Connecting Buttons or Switches	13
SigmaStudio Connection - Quick Start	14
Default Register Configuration in SigmaStudio	17
Writing to E2Prom – Burning Custom SigmaStudio Programs to Non-Volatile Memory with SigmaStudio	18
Example Projects Types for the KABD-430	20
2.1 Systems	20
Active 2-Way Monitors, Bookshelf Speakers, Tower Speakers, etc	21
Mono 3-Way Speaker	22
Customized Desktop Amplifier	22
Example SigmaStudio Projects.....	23
SigmaStudio Programming Guide	23
Specifications	24
Dimensions.....	24
Electrical Specifications.....	24
Audio Specifications.....	24
Version History.....	25

What is new with the KABD amps compared to the DSPB series?

The DSPB series was the first generation of DSP amplifier boards from Dayton Audio, and the KABD series builds on the success of that series by adding new features such as Bluetooth 5.0 and boards capable of up to 4 channels of amplification.

1. Potentiometers have been removed from the board, and replaced with 3-pin JST ports. In the optional cable pack for the KABD series, there are 4 potentiometers with cables to connect directly to these ports, no soldering required. This allows for convenient external volume controls, filter controls and more. It also allows easy access to multipurpose pins of the ADAU1701 for other purposes.
2. Bluetooth 5.0 with AptX HD streaming. High quality Bluetooth streaming is now built right onto the board. Example projects have been updated accordingly to use this input. If your SigmaStudio project is not setup correctly, you will not hear any input when connected with Bluetooth.
3. 4 Channels of amplification! Perfect for making a stereo pair of 2-way active speakers, both of the new 4 channel amplifiers use the BT 5.0 module w/aptX HD, and also allow for external potentiometers. The boards can also be configured into 2.1 mode, or higher powered 2.0 mode. Each board is smaller than a typical passive 2-way crossover, yet you get amplification, DSP and Bluetooth built in with no passive crossovers required. Make a crossover with DSP instead!
 - a) The KABD-430 will allow for 4 x 30 Watt channels of DSP and amplification in the same compact size as any previous KAB or DSPB amplifier. Configurable as 4x30W, 2x30W+1x60W, or 2x60W.
 - b) The KABD-4100 is a larger board, but allows for up to 4 x 100 Watts of DSP and amplification! Configurable as 4x100W, 2x100W + 1x200W, or 2x200W. This amplifier can also be cascaded with a second KABD-4100 for up to 8 channels of amplification.

What is the difference between a KABD amp and a KAB amp?

Dayton Audio's original line of Bluetooth amplifier boards is the KAB line, which have had numerous generations but always included class D amplification optimized for portable use and Bluetooth streaming. Compared to the KAB series, the KABD series of amps all include a dedicated DSP chip called the Analog Device's ADAU1701, which allows for connection to SigmaStudio and incredibly flexible DSP configuration such as on-the-fly tone controls, advanced bass processing, delays, etc. The previous DSPB series of amplifiers also employed this ADAU1701 DSP module, however it lacked Bluetooth support. The KABD series is like a combination of the KAB and DSPB series. The newest generation of KAB amplifiers employ the same Bluetooth 5.0 chips with aptX streaming and very similar connections, and for the first time, this generation of KAB also includes basic EQ capability with the KPX programmer (however it is not nearly as powerful or flexible as the ADAU1701).

KABD-430 Visual Overview

POT / GPIO Ports	
POT 1-4 PH-3Pos-2mm	
Pin	Definition
1	GND
2	MP9, MP8, MP3, MP2
3	3.3V

Standby	
J10 PH-2Pos-3mm	
Pin	Definition
1	GND
2	ENABLE

Line Input	
J13 PH-5Pos-2mm	
Pin	Definition
1	Left In
2	AGND
3	Right In
4	NC
5	NC

Programming	
via ICP1 or KPX programmer	
J4 PH-6Pos-2mm	
Pin	Definition
1	RST
2	+5V
3	GND
4	WP
5	SCL
6	SDA

I2S (Digital) Output	
J9 PH-6Pos-2mm	
Pin	Definition
1	LRCLK
2	BCLK
3	DATA
4	GND
5	+5V
6	NC

Battery Connector	
J5 For LBB Series Battery Boards	
PH-4Pos-2mm	
Pin	Definition
1	GND
2	GND
3	VCC
4	VCC

Bluetooth Antenna Connector	
External BT LED	
J1 PH-2POS-2mm	
Pin	Definition
1	LED-
2	LED+

BT Disconnect	
J2 PH-2Pos-3mm	
Pin	Definition
1	EN
2	+3.3V

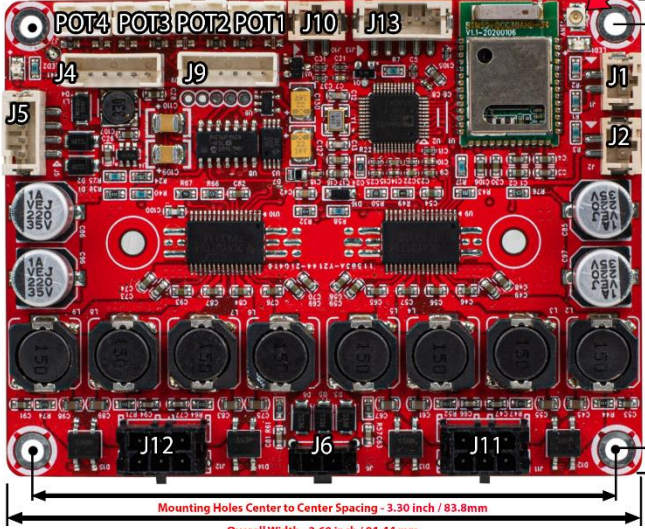

Speaker Output				
J12				
Molex-MicroFit-2x3Pos-3mm				
Pin	Stereo Mode		Mono Mode	
	Function	ADAU1701 Output	Function	ADAU1701 Output
1	GND	N/A	GND	N/A
2	MODE2		MODE2	
3	OUTR2-	DAC2	MONO2+	DAC2
4	OUTR2+		MONO2+	
5	OUTL2+	DAC3	MONO2-	
6	OUTL2-		MONO2-	

DC Power 12-26V	
J6 Molex Microfit 2Pos - 3mm	
Pin	Definition
1	VCC
2	GND

Speaker Output				
J11				
Molex-MicroFit-2x3Pos-3mm				
Pin	Stereo Mode		Mono Mode	
	Function	ADAU1701 Output	Function	ADAU1701 Output
1	GND	N/A	GND	N/A
2	MODE1		MODE1	
3	OUTR1-	DAC0	MONO1+	DAC0
4	OUTR1+		MONO1+	
5	OUTL1+	DAC1	MONO1-	
6	OUTL1-		MONO1-	

STEREO
CONNECT MODE TO GND

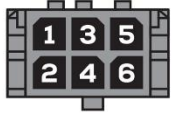
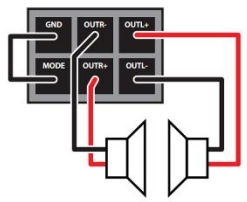

MONO
DISCONNECT MODE FROM GND

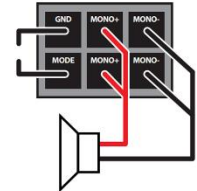

Quick Start and Wiring Guide

Before You Start

- Make sure that any speakers and input devices you plan on connecting to the KABD are working properly.
- If using SigmaStudio to use the full potential of the DSP, make sure you have purchased at least one programmer board (ICP1 or KPX), an appropriate USB cable capable of data transfer and make sure you have a Windows PC available to use for Analog Devices' free SigmaStudio software.
- Take care when attaching and especially removing jumper cables from the KABD.
 - A damaged cable can cause issues that are difficult to troubleshoot, such as noises like popping or clicking. A damaged cable can also cause programming failure.
 - A rocking motion can be helpful when removing cables from ports.
- Note that there is a 'tips and troubleshooting' section at the bottom of this document.
- This guide will frequently reference ports on the amplifier such as "J8" or "J6". These markings are written on the board itself in small print and are usually easy to find, but if unsure, reference the quick start wiring diagram below.

Power Supplies

- **DC Power** - The KABD-430 can be powered via J15 using the included wiring harness and DC jack with a DC power supply from 12-26V with current capabilities greater than 1A. Any power supply outside of this specification can damage the KABD-430. In general, the higher wattage the power supply, the more power that can be supplied to your speaker.
- **Battery Power** - The KABD-430 can also be easily powered with an external Dayton Audio battery board via J5. The KABD-430 does NOT have a battery charging circuit on the board, so the attached battery board must have this built in. **Dayton Audio battery boards such as the LBB-3v2 (12V) or LBB-5Sv2 (21V) will work with any KABD series amplifier.** Battery modules such as the Dayton Audio KAB-BE are not compatible with the KABD series because these battery modules do not have built in charging circuits (amplifiers such as the KAB-250v4 have charging circuits on the board, but the KABD-430 does not have this circuit on the board).

Input Devices

- **Bluetooth** - The KABD-430 has Bluetooth 5.0 built directly onto the board wired directly to the ADAU1701 DSP chip via I2S. This supports apt-X, aptX-HD, apt-X LL, SBC and AAC.
- **Analog** - Analog audio sources can be input to the KABD-430 via J13. A 3.5mm aux-in cable is available in the function cables kit for the KABD series.
- **Mixing** - By default, input from I2S (Bluetooth) and J5 (analog) are mixed together within the DSP before being sent for amplification. This allows for a smooth transition between aux and Bluetooth without the user needing to touch the speaker/amplifier. This can be reprogrammed via a custom SigmaStudio project. For example, you might use a switch to change between Bluetooth and AUX (analog). See the example projects pack for an example SigmaStudio project.

Speaker Outputs

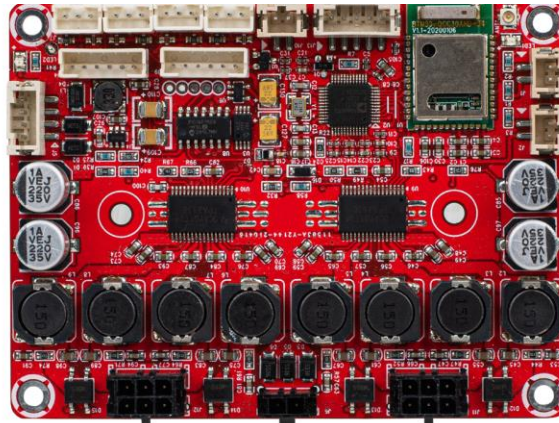

Speaker Output				
J12				
Molex-MicroFit-2x3Pos-3mm				
Pin	Stereo Mode		Mono Mode	
	Function	ADAU1701 Output	Function	ADAU1701 Output
1	GND	N/A	GND	N/A
2	MODE2	N/A	MODE2	N/A
3	OUTR2-	DAC2	MONO2+	DAC2
4	OUTR2+	DAC2	MONO2+	
5	OUTL2+	DAC3	MONO2-	
6	OUTL2-	DAC3	MONO2-	

J12

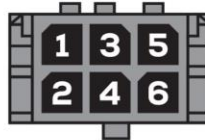

J11

Speaker Output				
J11				
Molex-MicroFit-2x3Pos-3mm				
Pin	Stereo Mode		Mono Mode	
	Function	ADAU1701 Output	Function	ADAU1701 Output
1	GND	N/A	GND	N/A
2	MODE1	N/A	MODE1	N/A
3	OUTR1-	DAC0	MONO1+	DAC0
4	OUTR1+	DAC0	MONO1+	
5	OUTL1+	DAC1	MONO1-	
6	OUTL1-	DAC1	MONO1-	

- The KABD-430 has 2 separate speaker output jacks (J11 and J12). These jacks are each attached to their own stereo amplifier modules for a total of 4 output channels. Each port also supports PBTl (bridged mode), allowing the KABD-430 to be configured into 4.0, 2.1, or even 2.0 configurations (however, we recommend the KABD-250 instead of the KABD-430 if 2.0 mode is desired).
- Pins 1 and 2 of the speaker output jacks will control the output mode. The included speaker wiring harnesses include male/female jumper connections to make configuring the output mode of each port simple. For stereo mode, connect the jumper wires together. For bridged/mono mode, leave them disconnected.
- The speaker outputs of the KABD-430 are stable down to 4 Ohm.

STEREO
CONNECT MODE TO GND

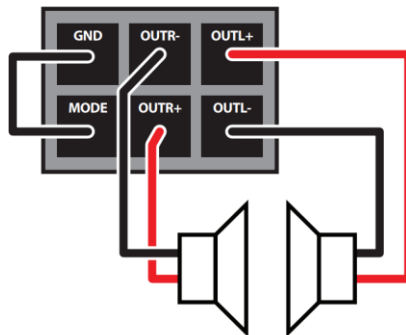

MONO
DISCONNECT MODE FROM GND

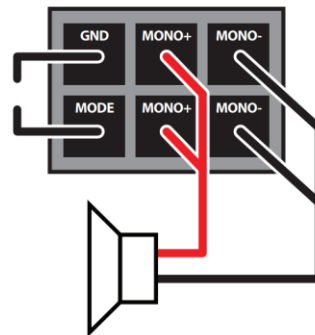

Quick Start Steps

1 Speaker Connection

Using the included wiring harnesses, wire your speakers to the harness as described in the section directly above. Connect the jumper for stereo mode on that port, or leave the jumper disconnected for mono mode.

Do not let speaker wires touch while the amplifier is powered. Do not switch the output mode while the amplifier is powered. Attach the wiring harness to your speakers before connecting to your KABD.

The minimum impedance of connected speakers is 4 Ohm in both Stereo and Mono Mode

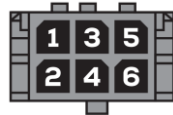

Speaker Output				
J11				
Molex-MicroFit-2x3Pos-3mm				
Pin	Stereo Mode		Mono Mode	
	Function	ADAU1701 Output	Function	ADAU1701 Output
1	GND	N/A	GND	N/A
2	MODE1	N/A	MODE1	N/A
3	OUTR1-	DAC0	MONO1+	DAC0
4	OUTR1+		MONO1+	
5	OUTL1+	DAC1	MONO1-	
6	OUTL1-		MONO1-	

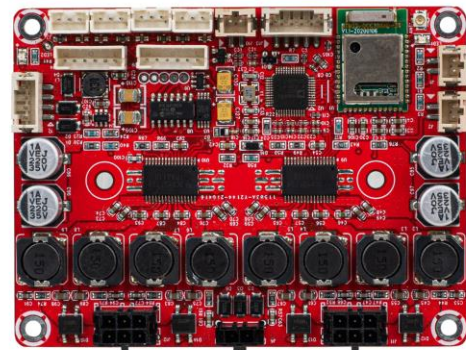

J12
STEREO
CONNECT MODE TO GND

J11
MONO
DISCONNECT MODE FROM GND

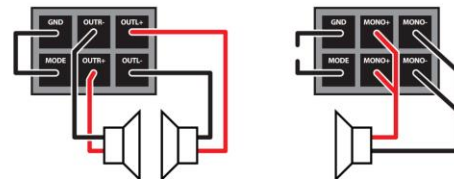

Speaker Output				
J12				
Molex-MicroFit-2x3Pos-3mm				
Pin	Stereo Mode		Mono Mode	
	Function	ADAU1701 Output	Function	ADAU1701 Output
1	GND	N/A	GND	N/A
2	MODE2	N/A	MODE2	N/A
3	OUTR2-	DAC2	MONO2+	DAC2
4	OUTR2+		MONO2+	
5	OUTL2+	DAC3	MONO2-	
6	OUTL2-		MONO2-	

2. Power Connection

Connect a center positive 10-39V DC power supply to J15 using the included wiring harness with pre-attached DC Jack.

Dayton Audio recommends at least 36V 5A power supply, but a 36V 10A power supply is recommended for maximum power.

DC Power (12-36V)	
J15	
Molex-4Pos-3mm	
Pin	Definition
1	GND
2	GND
3	VCC
4	VCC

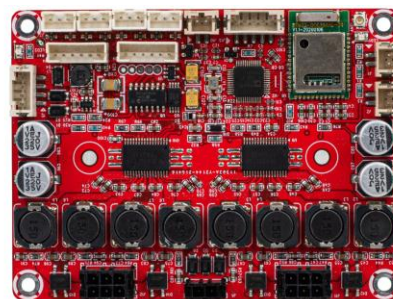

Batteries

The KABD-430 does not have a built-in battery charging circuit, so a **battery board such as LBB-3v2 (12V) or LBB-5Sv2 (21V) that has a charging protection circuit built in is required to use the amplifier with batteries.** If you are familiar with the KAB series from Dayton Audio, these boards include a battery charging circuit on the amplifier itself, thus the battery boards do not need to contain a charging circuit, but the KABD series need this circuit on the battery board itself.

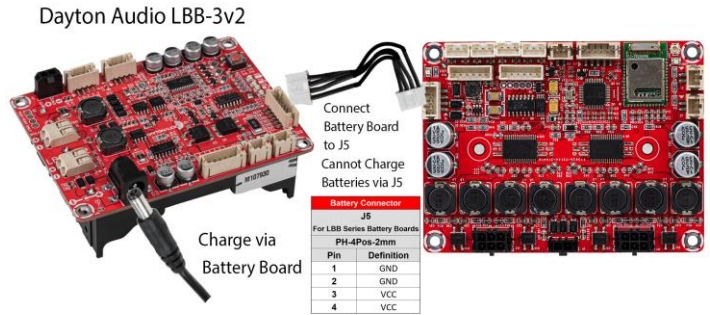

3. Bluetooth Pairing / Disconnect Switch

Attach the included green Bluetooth pairing switch with 2-pin JST connector to J2. If a different switch is desired, simply snip off the green button and solder your own to the 2-pin wiring harness. Only use momentary switches. Do NOT use a latching/toggle switch.

Holding this button down for about a second will allow a new device to be paired to the KABD, and will disconnect the old device. Do not hold this button for longer than 5 seconds. Use this button if you are not seeing “DAKAB” in your Bluetooth list.

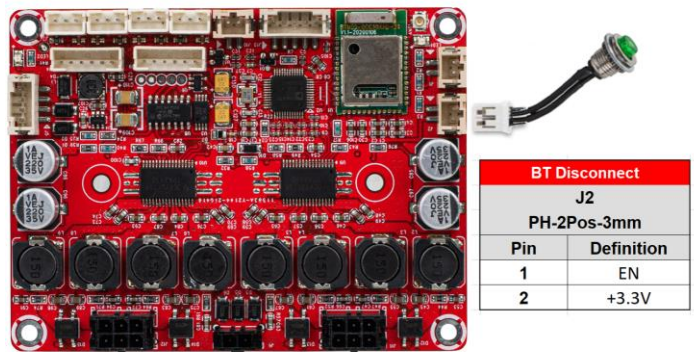

4. Bluetooth Connection

Once powered on, the board’s Bluetooth connection will be available on your phone, tablet, laptop, etc and will show as “DAKAB” in your Bluetooth menu. Once connected and music is playing on the source device, audio should begin playing through your connected speakers.

Troubleshooting

1. Check that your audio source is functioning correctly and connected to the KABD’s Bluetooth.
2. Check that your speaker connections match the diagram on the underside of the KABD.
3. If you had an ICP programmer attached to the KABD when the KABD was turned on, detach it and reboot your KABD.
 - a. Unpair and repair the KABD Bluetooth connection to your phone or other source device.

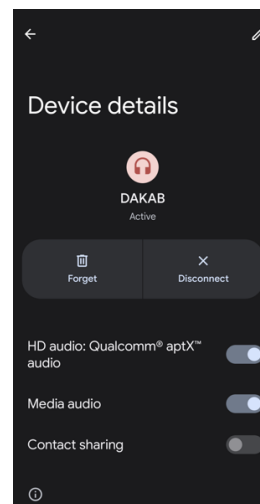

5. Bluetooth LED Connection (Optional)

A Bluetooth LED found in the functional cable kit can be added to the KABD-430 by plugging it into the corresponding 2-pin connector on the board, J1.

The Bluetooth LED will blink while searching for a device, but will be solid when a device is connected.

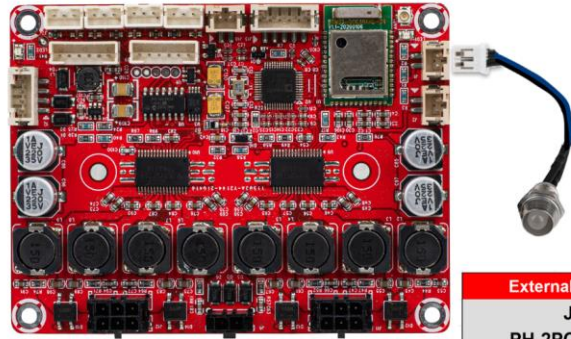

External BT LED	
J1	
PH-2POS-2mm	
Pin	Definition
1	LED-
2	LED+

6. Input Jack (Optional)

A 3.5mm aux input jack comes included in the functional cable pack, which can be plugged into J13 to function as a line input for external audio sources.

This wiring harness could be modified by snipping off the 3.5mm jack, and soldering stereo RCA jacks to the cables according to the pinout of the AUX IN port.

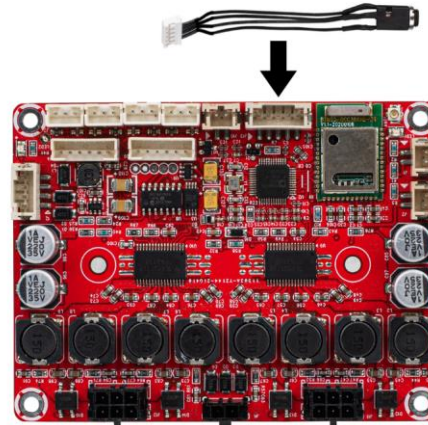

Line Input	
J13	
PH-5Pos-2mm	
Pin	Definition
1	Left In
2	AGND
3	Right In
4	NC
5	NC

7. Standby Switch (Optional)

There is a dedicated 2-pin standby port labelled J11. Any type of latching (toggle) switch can be used here, however included in the functional cable kit is a switch wired to a 2-pin connector that can be used as a standby switch. If this switch is not desired, the switch can be snipped off and the wiring harness can be used for a different style of toggle switch.

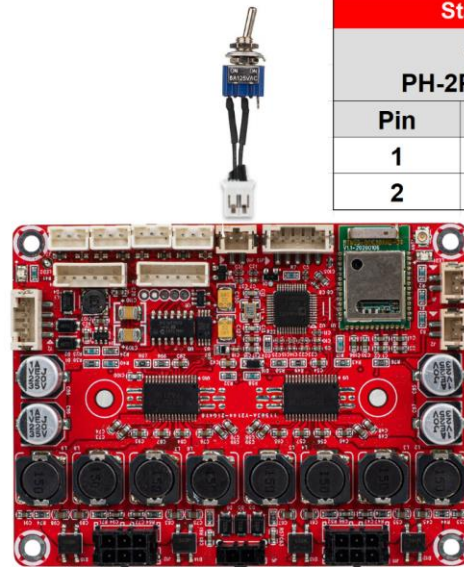

Standby	
J10	
PH-2Pos-3mm	
Pin	Definition
1	GND
2	ENABLE

8. Potentiometers (Optional)

Attaching the potentiometers found in the functional cable kit (sold separately) to the board in the 3-pin POT1-4 ports can allow quick on-the-fly adjustments, even without any programming. See the potentiometers section for more details. POT1 can immediately be used out of the box as an external volume control.

Numerous SigmaStudio example projects are available to reprogram the potentiometers for custom uses, such as EQ tone controls, high/low pass filters, custom volume controls, etc and can be easily customized.

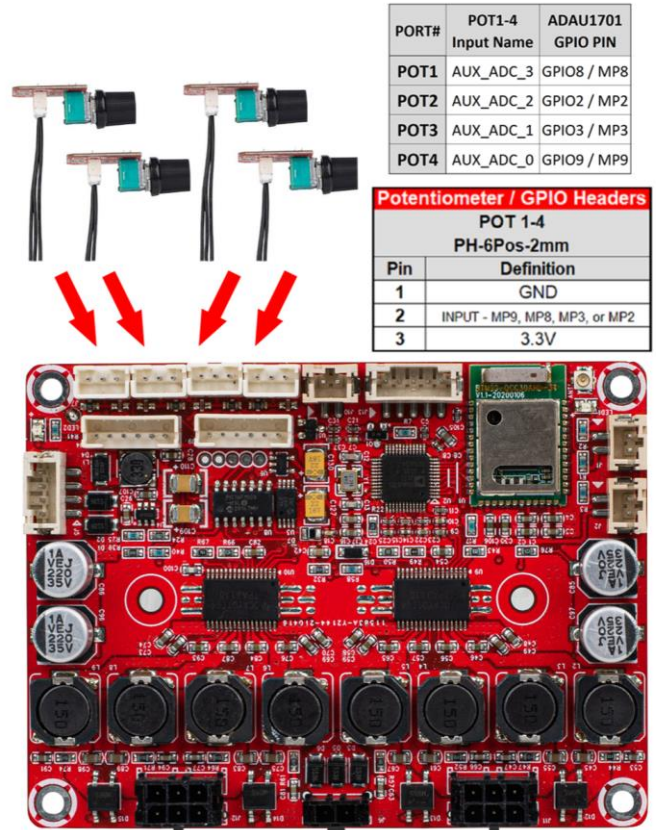

9. Bluetooth Antenna (Optional)

(Optional) Attaching the external Bluetooth antenna in the function cable kit can be helpful when the KABD is installed in situations where more range is needed, or if the Bluetooth signal is restricted, such as in a metal case.

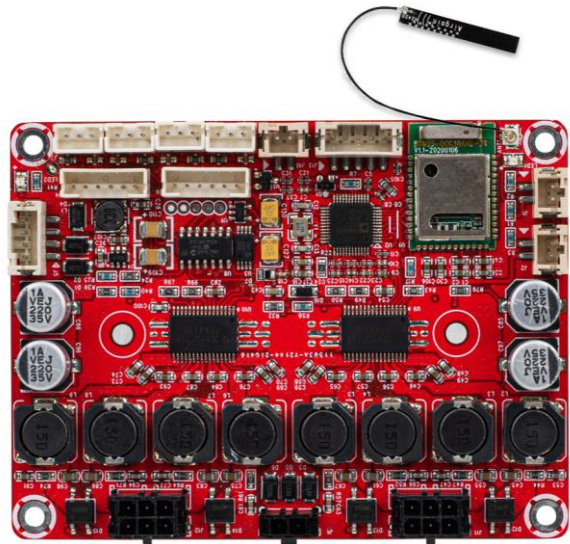

11. Programmer Connection (Optional)

Optional but highly recommended, Connecting a compatible programmer (Dayton Audio ICP1 or KPX) will allow you to connect the KABD's DSP chip to your PC, allowing you to create advanced DSP programs. This connection is temporary, and the programmer can be removed when finished. See the "SigmaStudio Connection" section of this document for more details.

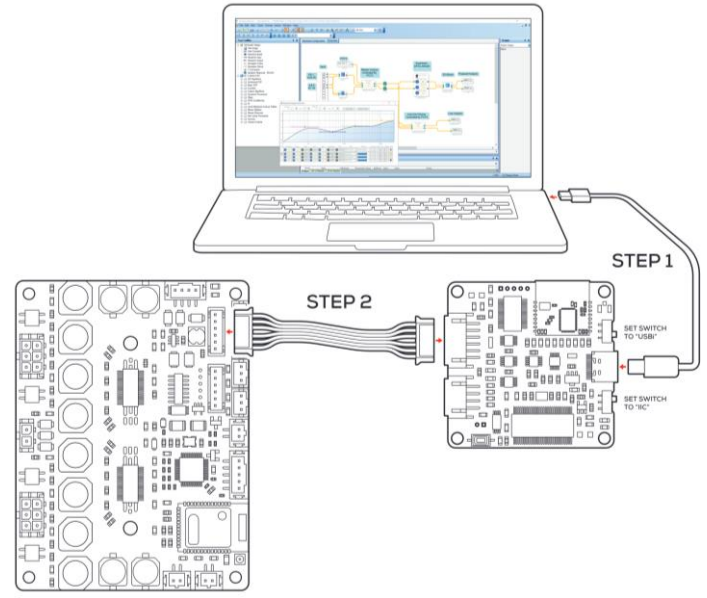

Potentiometer Headers

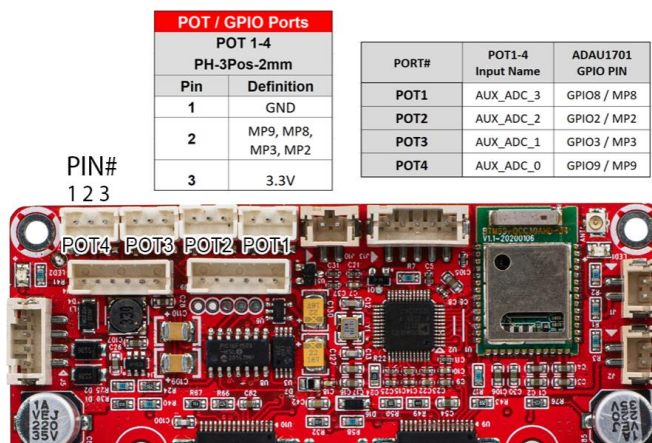

The KABD series of amplifiers come with four headers to make it easy to add external potentiometers, button, switches or rotary encoders to your project. Each of these 3-pin headers expose a voltage supply, GND, and a multipurpose pin of the ADAU1701. The optional cable pack for the KABD series comes with 4 potentiometers with cables that connect directly to these ports, so no soldering is required and they are easy to add to your project. The ports for these potentiometers are 3-pin JST headers and are clearly labelled as POT1-4. The potentiometers in the cable pack are 1k Ohm. Buttons or switches can also be easily attached to these ports and should connect to Pin 1 (GND) and Pin 2 (MP#) as labelled above and the corresponding multipurpose pin must be configured as “Input GPIO Debounce” as seen on the next page.

Out of the box, each KABD amplifier is pre-programmed for the potentiometers to have some basic functions, however there are numerous example projects for most other use cases and can be easily customized with SigmaStudio. A chart of the default potentiometer functions is below.

For instruction on how to use potentiometers or buttons/switches in SigmaStudio projects, see the “SigmaStudio for the KABD series” guide for detailed information.

Note: If the potentiometers for making on-the-fly adjustments, the potentiometers **must be left plugged in** for the changes to remain active. For example, if you use POT3 to enable a high pass filter on your speaker outputs, you must leave that potentiometer plugged in for the HPF to remain active. When you remove the potentiometers, the HPF will deactivate. If you do not want to leave the potentiometers plugged in for something like a high pass filter, you need to reprogram the board via SigmaStudio with your custom configuration and do the high pass filter within SigmaStudio.

KABD-430 Default Firmware Functions			
PORT#	4.0 Mode	2.1 Mode - J11 Bridged	2.1 Mode - J12 Bridged
POT1	J11 Volume (Relative)	J11 Volume (Relative)	J11 Volume (Relative)
POT2	J11 High Pass Filter	J11 Band Pass Filter	J11 High Pass Filter
POT3	J12 High Pass Filter	J12 High Pass Filter	J12 Band Pass Filter
POT4	Master Volume	Master Volume	Master Volume

Potentiometer Port Configuration in SigmaStudio

There is some configuration within SigmaStudio required so the ADAU1701 knows to interpret each multipurpose (MP) pin as a potentiometer input or button/switch input. Simply open the hardware configuration menu, then select the “IC 1 – 170x\140x Register Control” tab. Configure the MP pin that corresponds to your potentiometer header to “Input GPIO Debounce” for a button/switch, or “ADCX” for a potentiometer.

Any example project from Dayton Audio that you use will already have this preconfigured.

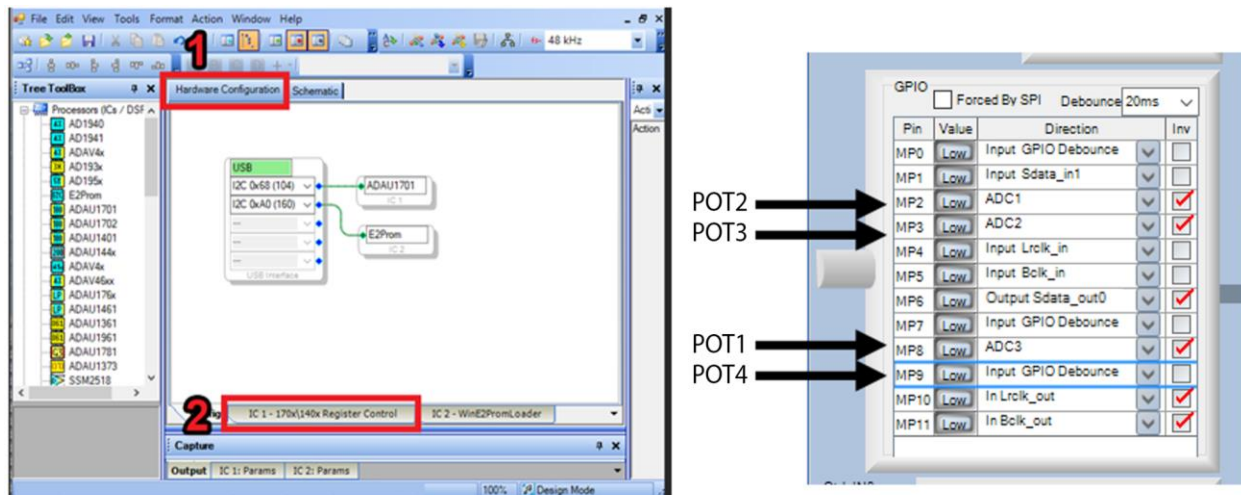

“ADC” is for Potentiometers
“Input GPIO Debounce” is for switches

Using the Potentiometer Ports for Connecting Buttons or Switches

The 4 potentiometer ports on the boards are optimized for potentiometers, however they can be easily used to instead connect buttons or switches to the ADAU1701, as they expose 4 of the multipurpose pins of the ADAU1701. Simply connect your switch to the GND and MP pin of the desired potentiometer port (Pin 1 and Pin 2 on the diagram below). Even though these are 3 pin headers, the 2-pin connector that comes attached to the LEDs, Bluetooth pairing button, etc will also fit, just not perfectly. There is a switch that comes in the optional KABD cable pack pre-wired to a 2-pin connector. The MP Pin must be set to “Input GPIO Debounce” in the register configuration like above to work as a button/switch.

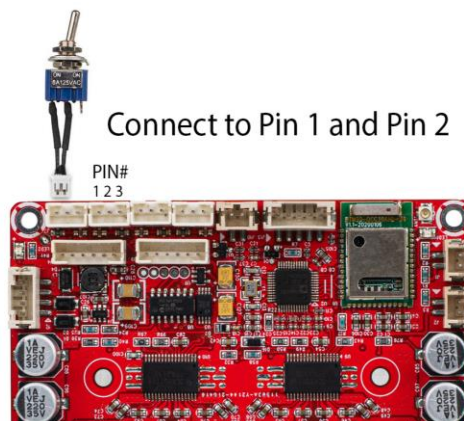

SigmaStudio Connection - Quick Start

A DSPB-ICP1 or KPX (USBi) programmer board is required to program the ADAU1701 DSP chip on KABD amplifiers. The programmer can be thought as the bridge between the DSP chip and the computer. The programming board translates instructions from the computer controlling SigmaStudio into a signal that the KABD's ADAU1701 can understand. The programmer only needs to be connected while the device is being programmed. After programming, it can be removed and used to program as many other KABD amplifier boards as needed.

Note that a comprehensive SigmaStudio guide for the whole KABD series is available wherever you found this document (the product page for the KABD-430) this section is merely to get you started in SigmaStudio, for detailed usage read that guide which is intended as a learning document that goes over all details needed to make custom projects such as input routing, output routing, bass algorithms, PEQ, controllable filters with potentiometers, presets switchable with a toggle switch, etc.

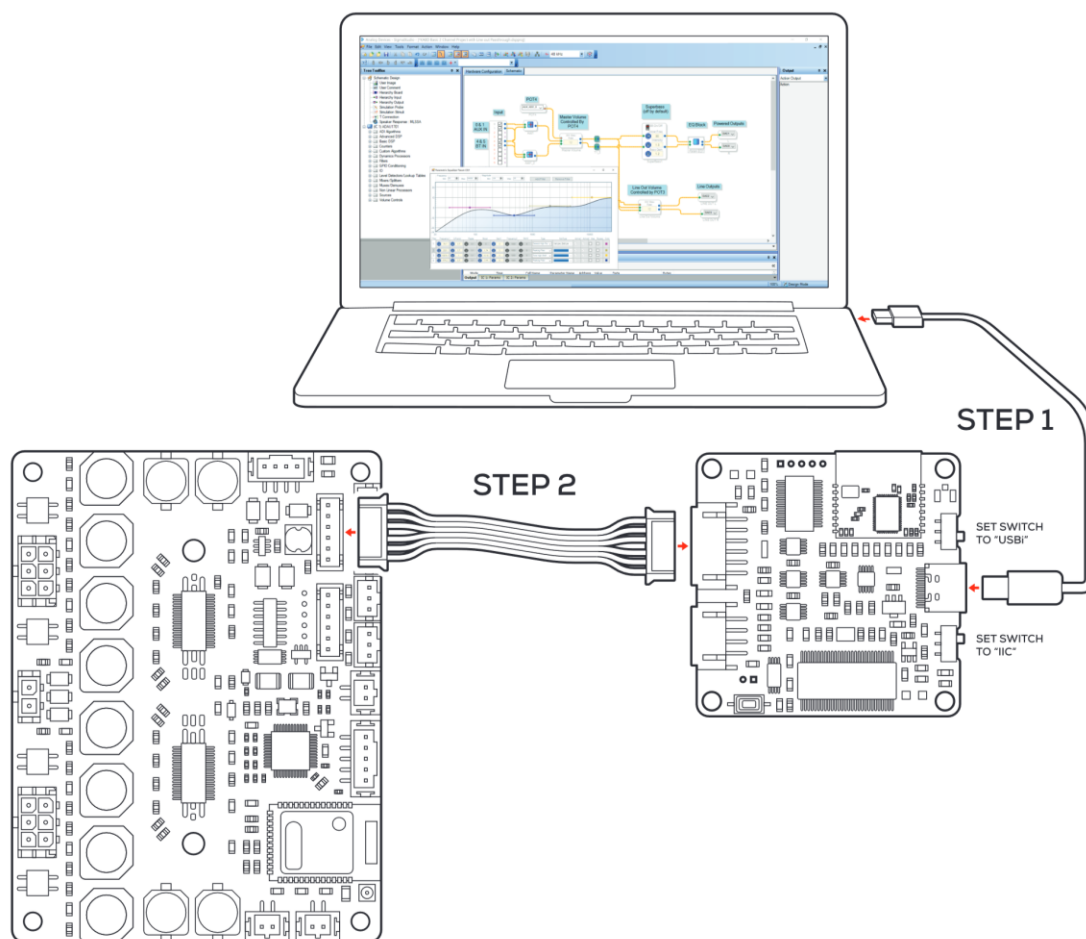

The graphic above demonstrates using a KPX Programmer to connect the KABD-430 to a laptop, however an ICP1 programmer will also work.

The following steps make it easy to connect your programmer to the SigmaStudio development tool, and then your programmer to your KABD amplifier. The steps require a basic knowledge of computer operation, but if the steps are followed closely, it is not too complicated. Please complete these steps in this order for consistent connection.

Note: Sigma Studio connection **requires a Windows PC and an ICP1 or KPX programming board.**

Steps

1. [Download and install the most recent version of SigmaStudio to your system for free.](#)
2. Make sure your ICP1 or KPX is disconnected from USB and from your KABD amplifier before starting, to ensure the proper steps are taken.
3. Open an example project from downloadable from the Parts Express product page for the KABD-430. (The example projects are in a zip file, and arranged into folders for each KABD type)
4. If starting a project from scratch (not recommended), open a new project in SigmaStudio by pressing File->New Project. We recommend using an example project and modifying it for your needs at least for the first time you re-program a KABD amplifier to make sure everything is working correctly.
5. Ensure that your ICP1 or KPX is **not** yet connected to the KABD. Set the switches on your ICP1 or KPX appropriately for programming the KABD.
 - a. **KPX** – Set the switches on your KPX are set to “USBi” and “IIC” for proper programming with the KABD.
 - b. **ICP1** – Set the only switch on your ICP1 to “PROGRAM” mode
6. Plug a micro USB cable (ICP1) or USB C cable (KPX) into the PC running SigmaStudio, and then connect that USB cable to your programmer
 7. If all is correct, you will see the USB block turn green, like below.

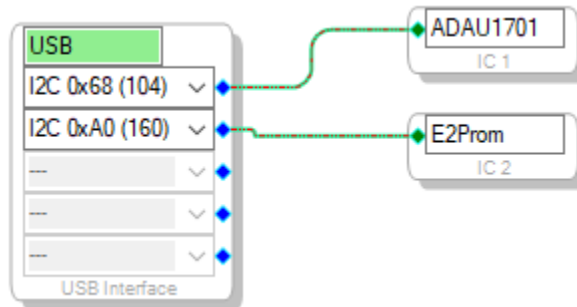

- a. Note that this block turning green means that SigmaStudio recognizes your programmer, **it does not indicate that SigmaStudio can communicate with your KABD amplifier yet.**
- b. If the connection is not successful (the block stays orange),
 - i. Disconnect all cables from the KPX / ICP1 (6-pin cable, 4-pin cable), and then plug in the USB cable to the KPX / ICP1.
 - ii. it is important to try a different USB cable, even if you think it's a 'good cable'. Many USB cables endure a lot of abuse from charging devices, and although they might still provide power, they might have issues transferring data. Some

Default Register Configuration in SigmaStudio

These are the default KABD-430 register settings. It is setup for proper I2S settings for Bluetooth Input (Master Mode) and or I2S input (Slave Mode) and I2S output. It also sets up the POT ports for potentiometers (if attaching switches to these ports instead, see the section about switches).

If using an example project for the KABD, this will already be configured for you. If upgrading a DSPB project or creating a project from scratch, make sure your register settings match the screen below. If unsure, modify an example project to suit your project's needs rather than starting from scratch.

The screenshot displays the Hardware Configuration window in SigmaStudio, showing the default register settings for the KABD-430. The window is divided into several sections:

- Serial Input:** Configured for I2S. The LRCLK polarity is set to 'L R' (Left Right). The BCLK data change is set to 'L R' (Left Right).
- Serial Output 1 (channels 0-7):** Configured for Master Mode. The LRCLK polarity is set to 'L R' (Left Right). The BCLK polarity is set to 'L R' (Left Right). The Frame Sync Type is set to 'LRCLK'. The Frame Sync Freq is set to 'internal clock/1'. The MSB Position is set to 'delay by 1'. The Word length is set to '24 bits'. The BCLK Frequency is set to 'internal clock/1'.
- DSP Core:** Program Length is set to '1x (1024 Instruct)'. RAM Module is set to '8'. Zero In/Out Registers is checked.
- GPIO:** A table of GPIO pins is shown, with MP1 through MP11 highlighted in yellow. MP2, MP3, MP8, and MP9 are marked with a red checkmark in the 'Inv' column, indicating they are configured for potentiometers.
- Register Table:** A table of registers is shown, including Core, GpioAll, SerialOut1, SerialInput, MpCfg0, MpCfg1, AnalogPower, AnalogInterfa, and Reg0 through Reg6.

MP2, MP3, MP8 and MP9 are for potentiometers.

Writing to E2Prom – Burning Custom SigmaStudio Programs to Non-Volatile Memory with SigmaStudio

This step writes your custom program to non-volatile memory on the KABD amplifier. This means that the program will be retained on the KABD even after it has been turned off and then back on again. This can be reprogrammed as many times as needed. When you are programming via SigmaStudio and making changes on the fly, the program is only stored in TEMPORARY memory. It is not until you write the program to E2Prom that your custom program can be reprogrammed to the DSP as the board turns on. **If you find that your custom program is lost on a power cycle, it means you have not written the program to E2Prom.**

IMPORTANT – This step will erase the stock configuration of the board! This means that the default functions of POT1-4 will be reprogrammed or removed, depending on the custom SigmaStudio project that is burned. See the project pack for original firmware for the KABD-430.

1. This guide assumes that you have successfully re-programmed your board with a custom program using the 'link compile download' button , and you are ready to burn it to the E2Prom memory (it can be rewritten as many times as desired).
2. Right click your "ADAU1701" block and click "Write Latest Compilation to E2PROM". This means it will burn the latest program you have compiled to E2Prom. This means the program that was configured the last time you pressed "Link Compile Download" or just "Link Compile Connect". If this option is greyed out, it means you need to press Link Compile Download and run a program on your KABD first.

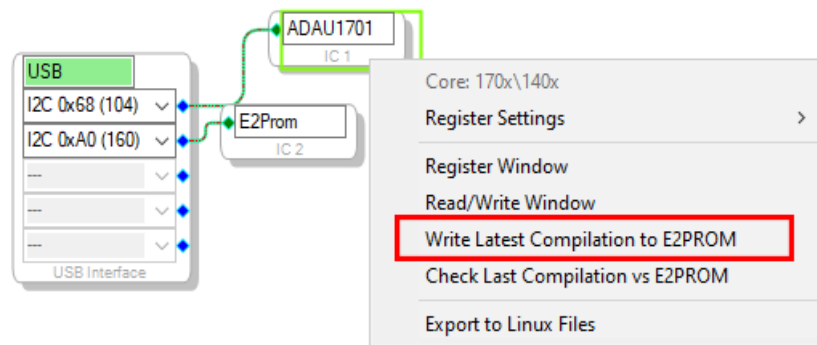

3. In the window that opens, make sure the settings match what is in the screenshot below (they are the default settings), and press OK.
 - a. NOTE: Your programmer's switch(es) need to be set properly for this step to work.
 - i. The ICP1 switch's position must be set to "PROGRAM"
 - ii. The KPX's switches must be set to "USBi" and "IIC".

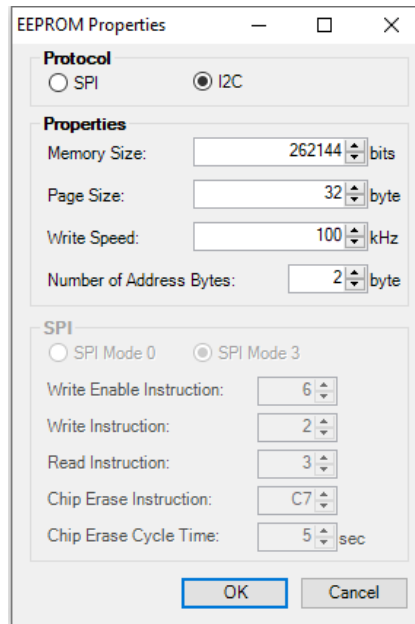

4. The program should now be written to E2PROM after it finishes programming. This means you can remove your programmer from the KABD, and your program should remain programmed on the board after power cycling the KABD.

Example Projects Types for the KABD-430

Despite its compact form factor, the KABD-430 is a very capable amplifier, and there is no limit to the kind of projects that can be achieved with it. Download the SigmaStudio programming guide for the KABD series and the project pack found on the product page of the KABD-430 for details about how the necessary DSP programming can be achieved to achieve these projects.

2.1 Systems

Creating a 2.1 system (A stereo pair of speakers, plus a subwoofer) fully powered by the KABD-430 is as easy as using one of the output jacks in stereo mode (to power your speakers) and using the other speaker output in bridged/mono mode to power your passive subwoofer. By building the KABD-430 into your subwoofer, this could clear up much needed room on your desk, TV stand, etc.

Example Projects :

“2.1 Project with Preset Switching via GPIO Switch.dspproj”

“2.1 Speaker Project with Potentiometer Tone Controls.dspproj”

“Simple 2.1 Project.dspproj”

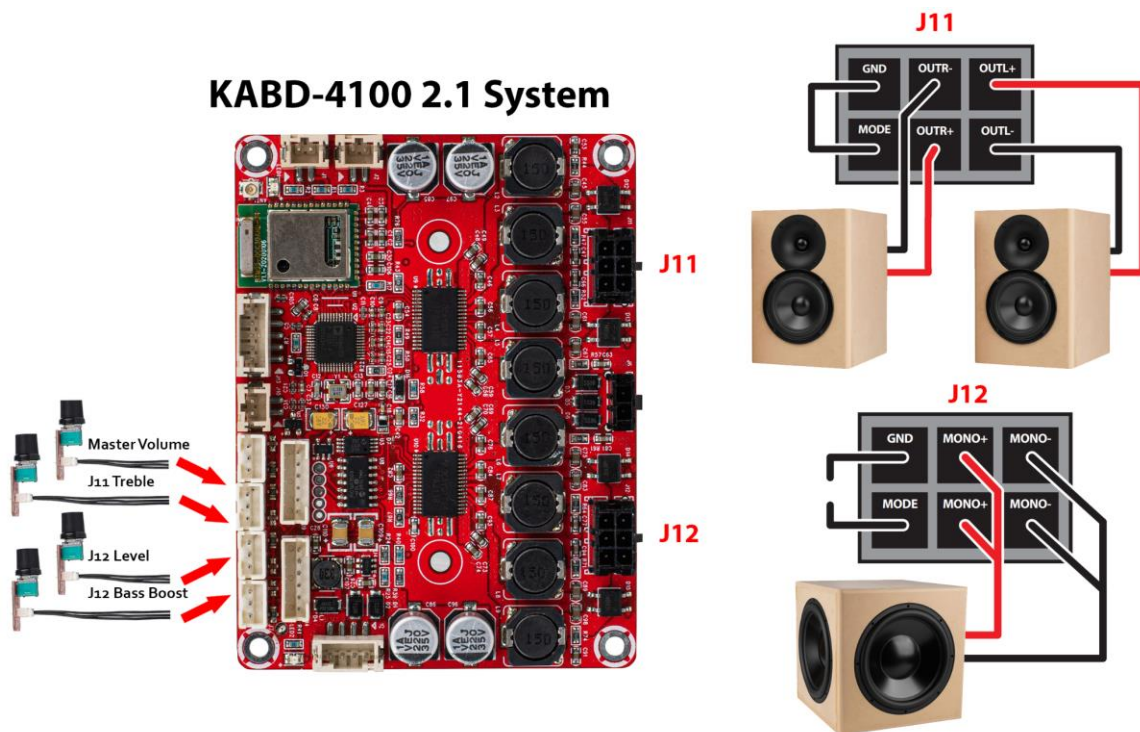

Active 2-Way Monitors, Bookshelf Speakers, Tower Speakers, etc

With a 4 channel KABD amplifier, making a pair of completely custom 2-way speakers has never been easier. 4 channels mean complete DSP control and power for each woofer and tweeter in a 2-way design. The power of DSP means there is no need to build multiple iterations of crossovers to get the sound exactly how you want it. Simply keep configuring DSP settings such as crossover filters, EQ phase adjustment and more until you have the perfect sound.

Example Projects :

“Simple Stereo 2-Way Speaker Project.dspproj”

“Stereo 2-Way Speaker Project with Potentiometer Tone Controls .dspproj”

“Stereo 2-Way Speaker Project with Preset Switching via GPIO Switch.dspproj”

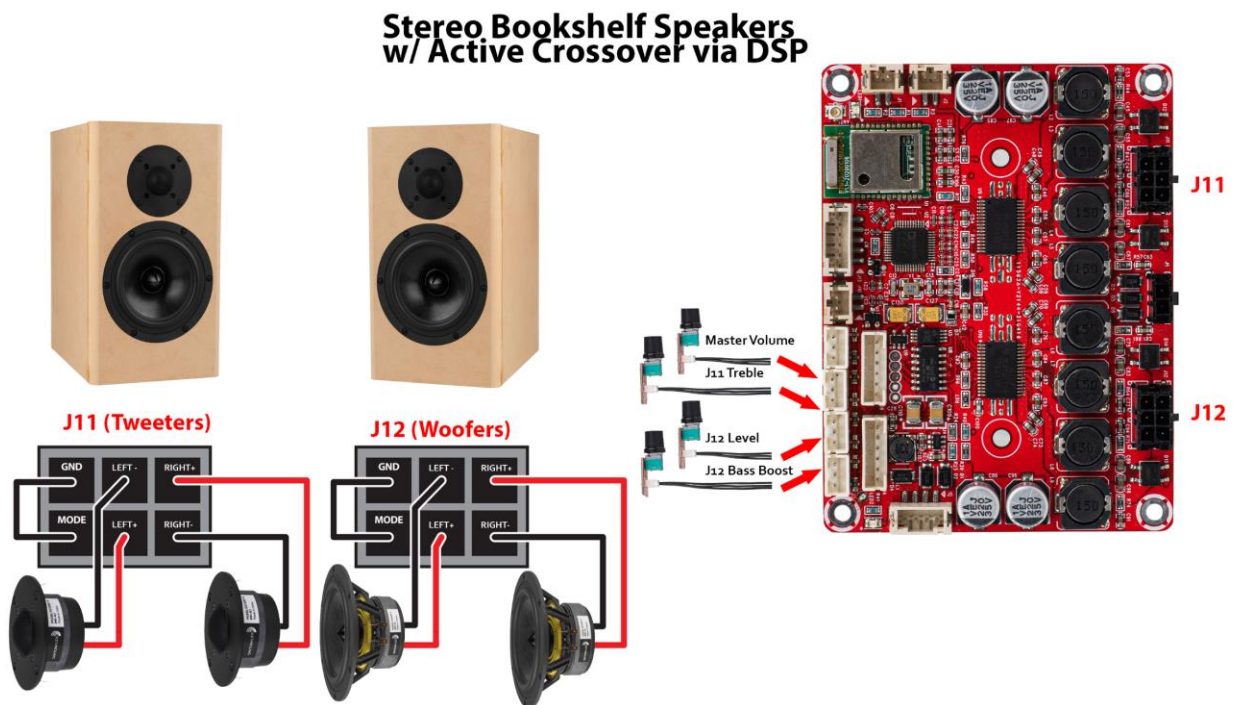

Mono 3-Way Speaker

Using a similar configuration as a 2.1 system, the KABD-430 could also be used to create a mono 3-way speaker. Simply use one output in stereo mode to power your tweeter and midwoofer, then use the second output in bridged mode to power your woofer. Within SigmaStudio, the stereo audio signal can be mixed to mono and a 3-way crossover block can be used. The example project also has optional volume controls to control tweeter and woofer levels with separate potentiometers, but these can of course be removed if not desired.

Example Project – *“Mono 3-Way Speaker Project”*

Customized Desktop Amplifier

It is possible to create a completely customized 4CH, 2.1CH, or even 2.0CH DSP amplifier with the KABD-430 for desktop usage. For example, you might create a customized case that will house the KABD-430 and a high power DC supply. You can then add all of the ins/outs of the KABD-430 to this case, such as binding posts for speakers, RCA jacks for input, and up to 4 potentiometers to control various functions.

What makes the KABD-430 uniquely suited for this task is not only programmable DSP and high-quality Bluetooth streaming, but the ports for external potentiometers that can be completely customized for a large range of functions. For example, you might add a master volume control, an 0.1 subwoofer volume control, a custom bass boost filter, treble control, midrange control, balance control, presets for specific situations or nearly any other filter you can think of.

Example Project : Nearly all/any of the project examples could be used for this type of project. It depends on what style of amplifier you want.

Example SigmaStudio Projects

On the product page for the KABD-430, you will find a zip file that contains numerous project examples for the entire KABD series, many of which are referenced throughout this manual. There is a folder in the zip for projects that specifically apply to the KABD-430. For further descriptions of the projects, see the end of (but read all of) the “SigmaStudio Programming Guide for the KABD Series of Amplifiers” Guide. You will find pre-configured and easily modifiable projects with features such as bass enhancement, on-the-fly tone control with potentiometers, on-the-fly preset switching, 2-way speaker projects, 3-way projects and so much more.

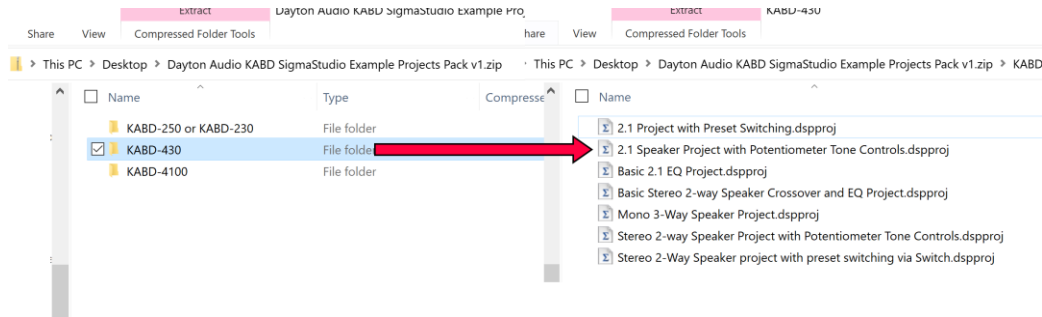

SigmaStudio Programming Guide

On the product page for the KABD-430, you will find a PDF file that is an extensive SigmaStudio guide tailored specifically for the KABD Series of amplifiers. This guide goes over usage of every DSP block used in the example projects, as well as going over most of the example projects themselves. Although the example projects are easy to modify and use for your purposes without understanding the entire DSP chain, the SigmaStudio programming guide serves as a resource for understanding every detail of the DSP projects, and can also be a good learning guide for learning DSP via SigmaStudio in general.

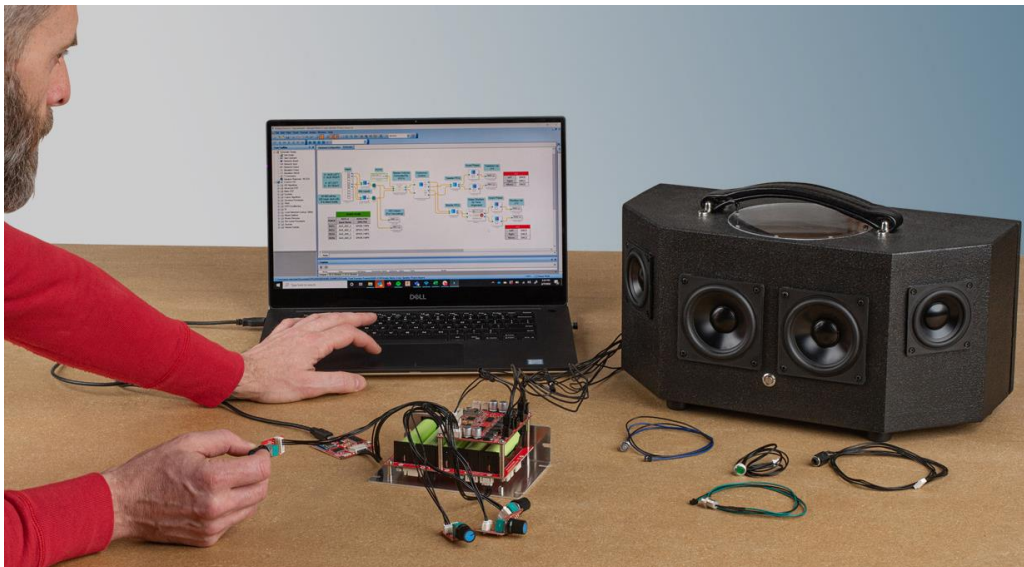

Specifications

Dimensions

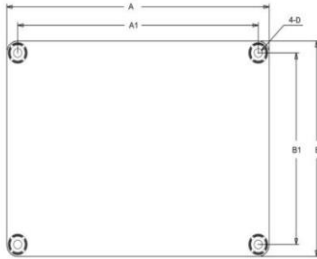

Dimensions	A (inch/mm)	A1 (inch/mm)	B (inch/mm)	B1 (inch/mm)	D (inch/mm)
	3.60/91.44	3.30/83.8	2.70/68.6	2.40/61.0	0.14/3.6

Notes:

- All dimensions are typical in inches/mm. Height = 0.79inch / 20mm
- Tolerance x.xx = $\pm 0.02(\pm 0.50)$
- The height is measured from the bottom of the PCB to the highest part of the components.

Electrical Specifications

Measurements taken at 24V DC input.

Parameter	Conditions	Min.	Typ.	Max.	Units	
Number of Channels	-	-	4	-	-	
Minimum Load Impedance	-	-	4	-	Ω	
Efficiency	4 x 30W@8Ohm, 1kHz	-	87	-	%	
Nominal Power Requirement	@24V, 1kHz	-	140	-	W	
Operating Voltage	@1kHz, 8Ohm	10	24	26	V	
Idle Power	Signal detected	-	3.2	-	W	
	No Signal detected	-	1.2	-	W	
Switching Frequency	SD Floating@24V	-	400	-	kHz	
Power Consumption	1/4 of max output power@8Ohm, 24V, 1kHz	-	31	-	W	
	1/8 of max output power@8Ohm, 24V, 1kHz	-	17	-	W	
Control	Standby (Low = inputs enabled)	High-level Input Voltage	3.3	-	-	V
		Low-level Input Voltage	-	-	0.8	V
	Mute (High = outputs enabled)	High-level Output Voltage	3.3	-	-	V
		Low-level Output Voltage	-	-	0.8	V
Standby Power	SD short to GND, only when low power module available	-	86	-	mW	

Audio Specifications

Measurements taken at 24V DC input.

Parameter	Conditions	Min.	Typ.	Max.	Units	
Number of Channels	-	-	4	-	-	
Minimum Load Impedance	-	-	4	-	Ω	
Efficiency	4 x 30W@8Ohm, 1kHz	-	87	-	%	
Nominal Power Requirement	@24V, 1kHz	-	140	-	W	
Operating Voltage	@1kHz, 8Ohm	10	24	26	V	
Idle Power	Signal detected	-	3.2	-	W	
	No Signal detected	-	1.2	-	W	
Switching Frequency	SD Floating@24V	-	400	-	kHz	
Power Consumption	1/4 of max output power@8Ohm, 24V, 1kHz	-	31	-	W	
	1/8 of max output power@8Ohm, 24V, 1kHz	-	17	-	W	
Control	Standby (Low = inputs enabled)	High-level Input Voltage	3.3	-	-	V
		Low-level Input Voltage	-	-	0.8	V
	Mute (High = outputs enabled)	High-level Output Voltage	3.3	-	-	V
		Low-level Output Voltage	-	-	0.8	V
Standby Power	SD short to GND, only when low power module available	-	86	-	mW	

Version History

V1.0 (2/9/2022) – Initial Release of the KABD-430 user manual.

Launched at the same time as:

- the SigmaStudio guide for the KABD Series v1.0 . PDF
- KABD Series SigmaStudio Example Projects v1.0 .ZIP