



# **500W SUBWOOFER PLATE AMPLIFIER with DSP**

Model: SPA500DSP  
User Manual

## Safety

1. Read these instructions.
2. Keep these instructions.
3. Heed all warnings.
4. Follow all instructions.
5. Do not use this apparatus near water.
6. Clean only with dry cloth.
7. Do not block any ventilation openings. Install in accordance with the manufacturer's instructions.
8. Do not install near any heat sources such as radiators, heat registers, stoves, or other apparatus (including amplifiers) that produce heat.
9. Do not defeat the safety purpose of any polarized or grounding-type plug. A polarized plug has two blades with one wider than the other. A grounding type plug has two prongs and a third grounding point. The wide blade or the third prong are provided for your safety. If the provided plug does not fit into your outlet, consult an electrician for replacement of the obsolete outlet.
10. Protect the power cord from being walked on or pinched particularly at plugs, convenience receptacles, and the point where they exit from the apparatus.
11. Only use attachments/accessories specified by the manufacturer.
12. Use only with the cart, stand, tripod, bracket, or table specified by the manufacturer, or sold with the apparatus. When a cart is used, use caution when moving the cart/apparatus combination to avoid injury from tip-over.
13. Unplug this apparatus during lightning storms or when unused for long periods of time.
14. Refer all servicing to qualified service personnel. Servicing is required when the apparatus has been damaged in any way, such as power-supply cord or plug is damaged, liquid has been spilled or objects have fallen into the apparatus, the apparatus has been exposed to rain or moisture, does not operate normally, or has been dropped.
15. **WARNING:** To reduce the risk of fire or electric shock, this apparatus should not be exposed to rain or moisture and objects filled with liquids, such as vases, should not be placed on this apparatus.
16. To completely disconnect this equipment from the mains, disconnect the power supply cord plug from the receptacle.
17. The mains plug of the power supply cord shall remain readily operable.

### IMPORTANT SAFETY INSTRUCTIONS

To reduce the risk of electric shock, do not remove cover. No user serviceable parts inside. Refer servicing to qualified personnel. To reduce the risk of fire and shock do not expose unit to rain or moisture. The unit should be connected to an earth grounded AC electrical socket. The unit should be operated in a well ventilated area. Minimum clearance is 2 inches from the ventilation openings.

**Note:** Unit is set at the factory for 120V operation. Be sure to change the fuse

(2A rating) before switching to 230V operation.



# FCC Statement

1. This device complies with Part 15 of the FCC Rules.

Operation is subject to the following two conditions:

(1) This device may not cause harmful interference, and

(2) This device must accept any interference received, including interference that may cause undesired operation.

# Operating Guide: Dayton Audio SPA500DSP Subwoofer Power Amplifiers

## Table of Contents

Back panel and input/output (I/O) definition.....	5
SPA500DSP wiring.....	6
Amp system block diagram.....	7
DSP processing block diagram.....	7
Controlling your subwoofer via PC GUI.....	8
Volume/Phase.....	9
LPF and Subsonic.....	10
5-Band PEQ.....	11
Limiter.....	12
High Frequency Out.....	13
Feature Menu display.....	14-15
Firmware update guide.....	16-20
DSP Functions.....	21
Feature Controller (LCD matrix, single-knob).....	21
Advanced Control (for GUI via USB port, PC).....	21
Base Specifications (Audio Precision®).....	22

# Back panel and input/output definition

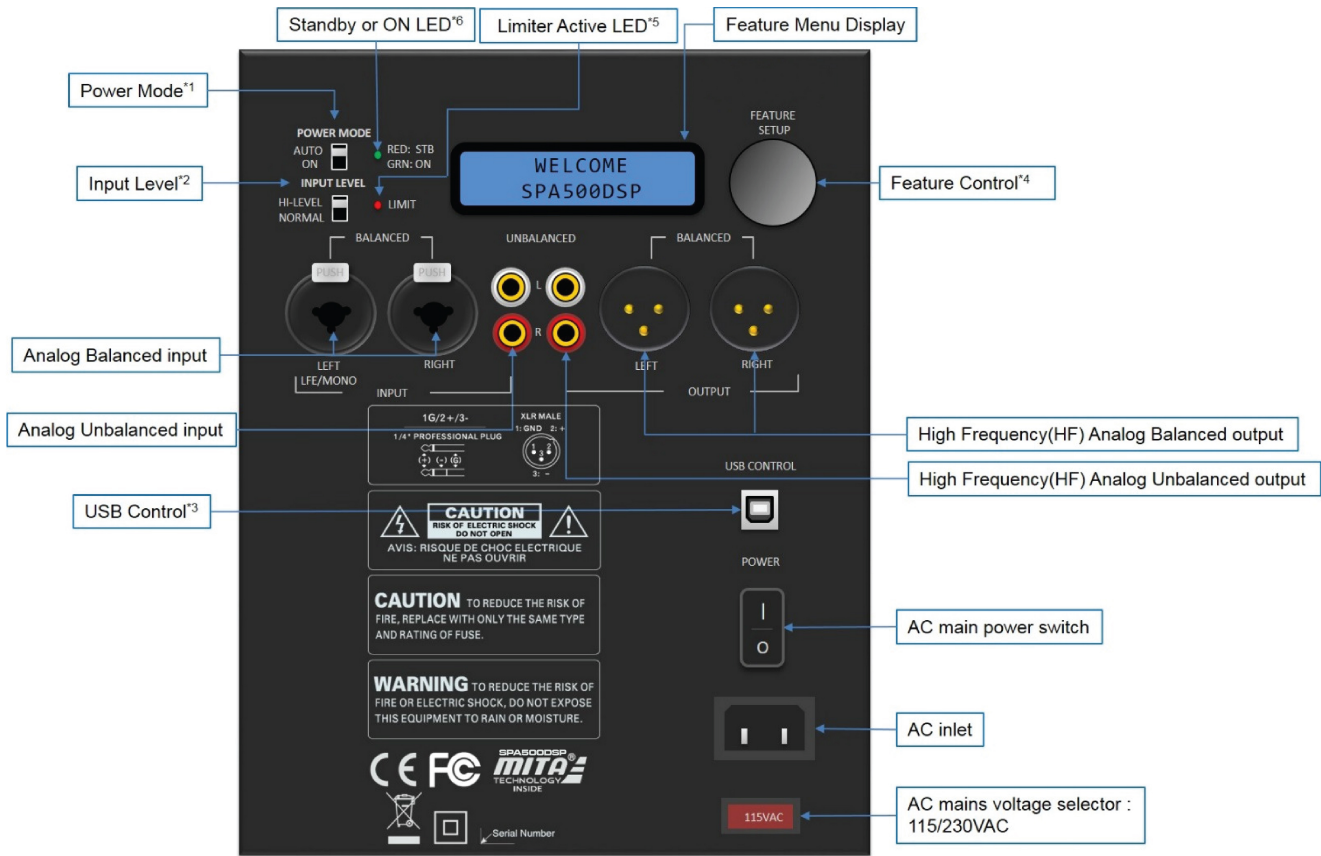

1. **Power Mode:** Select the either energy-saving or “always-on” power mode
  - o **Auto:** Amp goes into standby after no detected signal input for 20 minutes\*
  - o **On:** Amp is always on, regardless of input signal status.

\* Amp will automatically turn on typically in one second or less once audio signals are resumed.
2. **Analog input attenuation:** Affects analog balanced and unbalanced inputs only.
  - o **Normal:** No attenuation.
  - o **Hi:** Attenuates input signal by -6dB.
3. **USB Control:** Used for PC-GUI communication with custom PC software included with your amp. Please refer to **PC-GUI user guide** on [Page 8](#). USB also allows for **firmware update** by Dayton Audio release. See [Page 16](#) for more on the system “flash” update process.
4. **Feature Control:** Single knob digital actuator with single/double-click enabled with rotary scrolling to navigate the amp’s extensive feature menu.
5. **Limiter LED:** Lit when Limiter is active (Red).
6. **Standby/On LED:**
  - o Red when amp is in energy saving “stand by” state.
  - o Green when amp is operating normally.

# SPA500DSP wiring

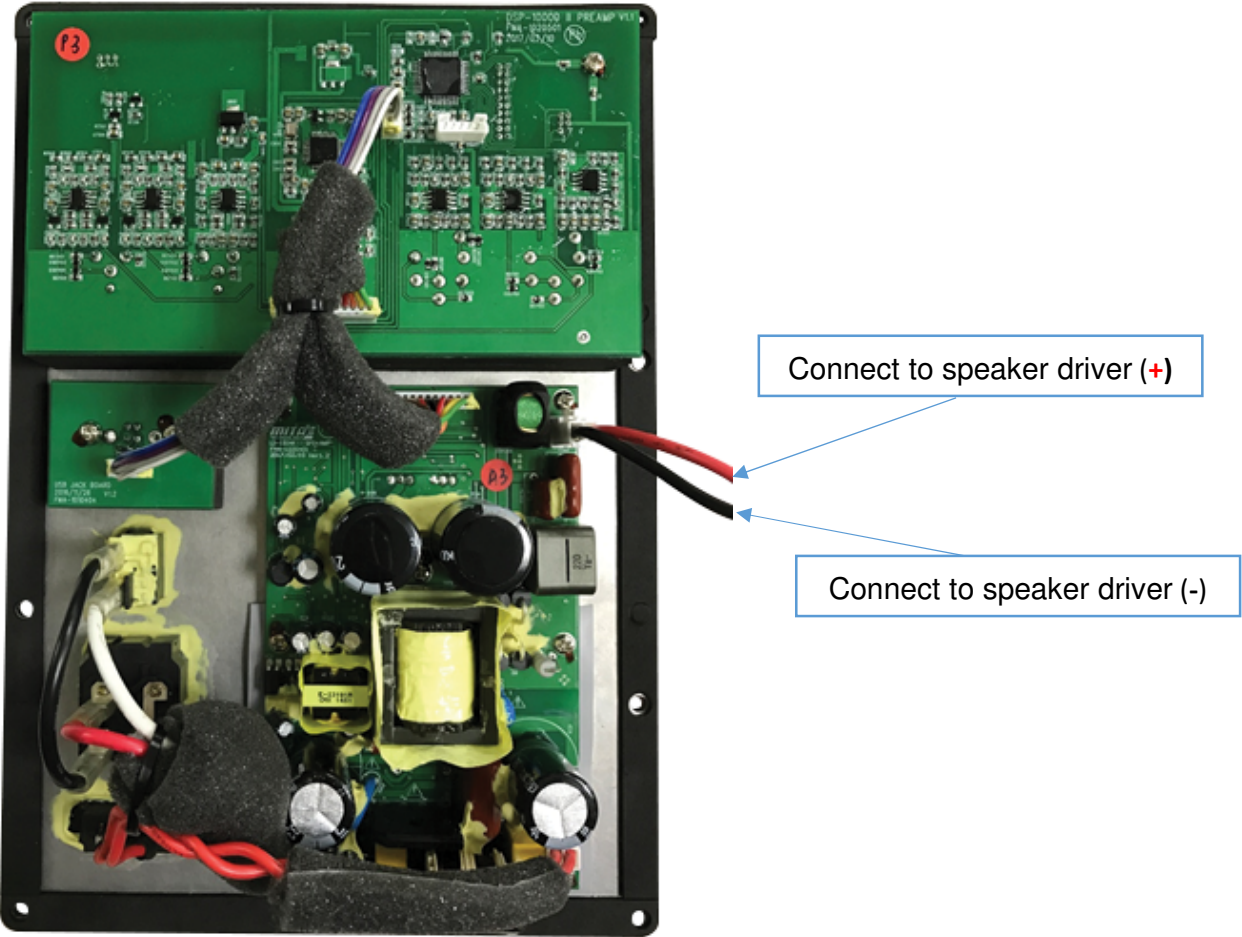

# Amp system block diagram

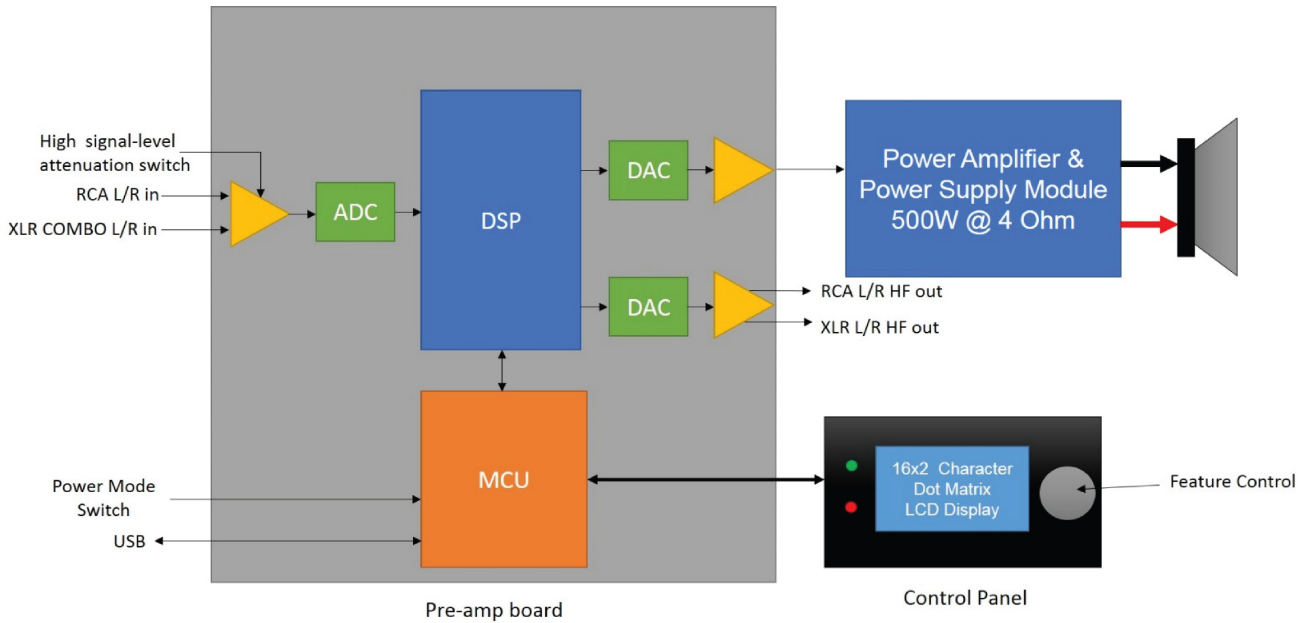

# DSP processing block diagram

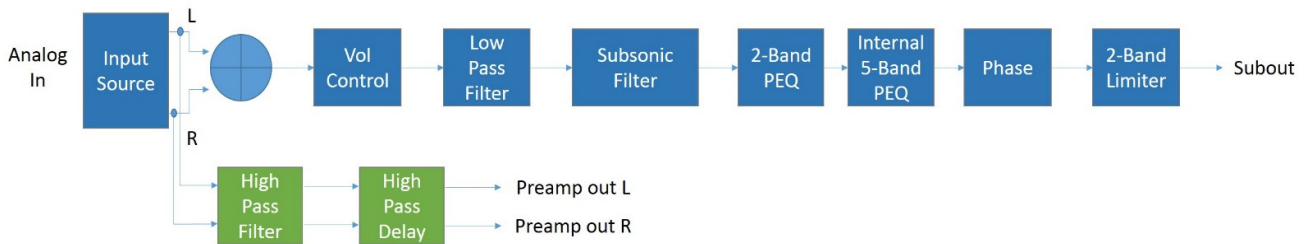

# Controlling your subwoofer via PC GUI

The PC GUI (literally “Personal Computer, Graphical User Interface”) is the primary mode to access and adjust the DSP for subwoofer optimization. Follow all safe practices and contact Dayton Audio if you require assistance.

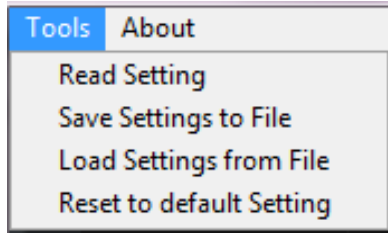

**Read Setting:** Read all the setting from amp

**Save Settings to File:** Save current settings to PC

**Load Settings from File:** Load previous saved setting to AMP



**Reset to default setting:** Reset the AMP to factory default

**See next page:** For a full depiction of the primary screens and detailed identification of each of your amp GUI's controls.

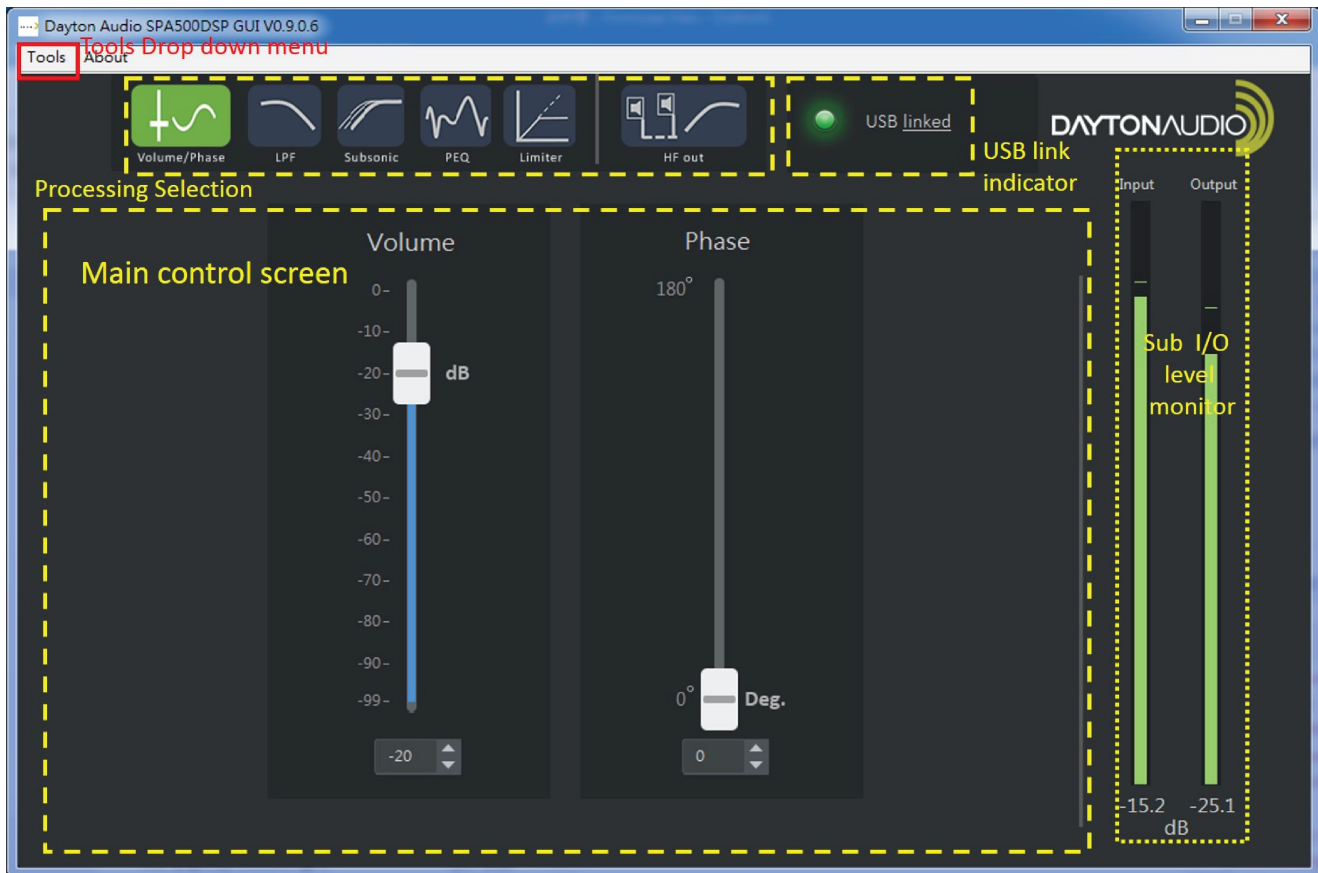

# Volume/Phase



- **USB link indicator:**  `USB linked` When the communication via USB with amp is successful, the GUI's LED indicator will light green. Otherwise, "LED" stays red.  `USB disconnected`
- **Processing Selection:** Navigate across the DSP menu to adjust various DSP parameters.
- **Sub in/out monitor:** Monitor the **input signal** and **sub output signal levels**.
- **Tools Drop Down Menu:** Utilities for amp DSP management.

# LPF and Subsonic

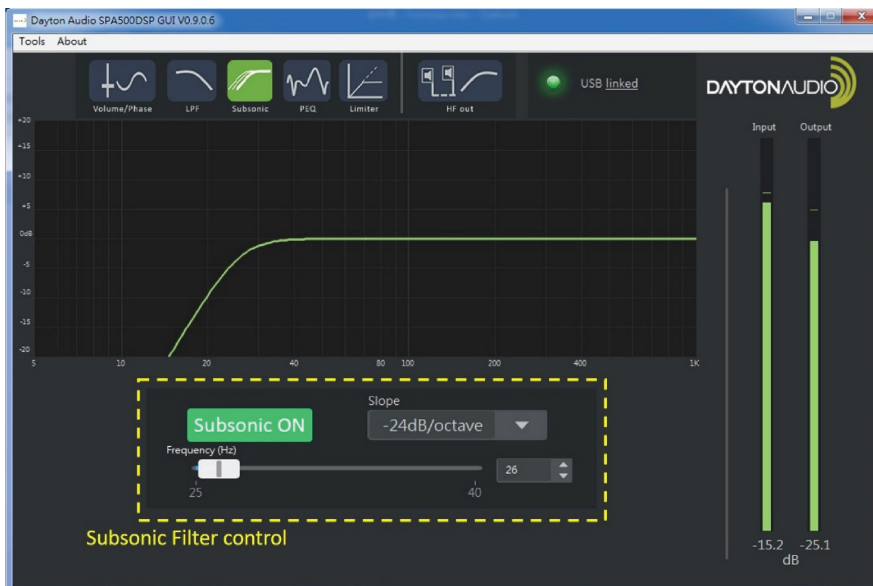
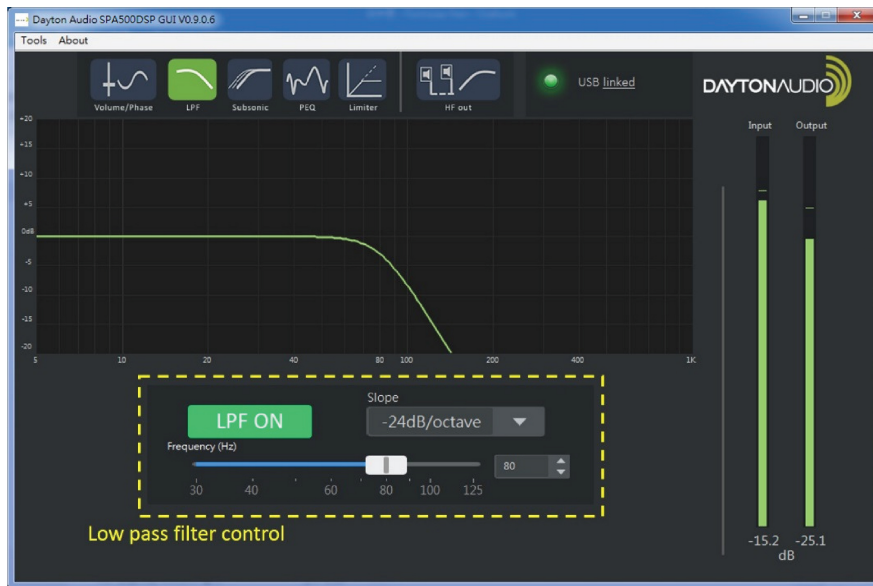

- **Filter ON/OFF Button:** Enable or disable the selected filter.
- **Slope:** Select roll-off gradient of the selected filter: -12dB/-24dB per octave.
- **Frequency (Hz):** Adjust cut-off frequency of the selected filter.

# 5-Band PEQ

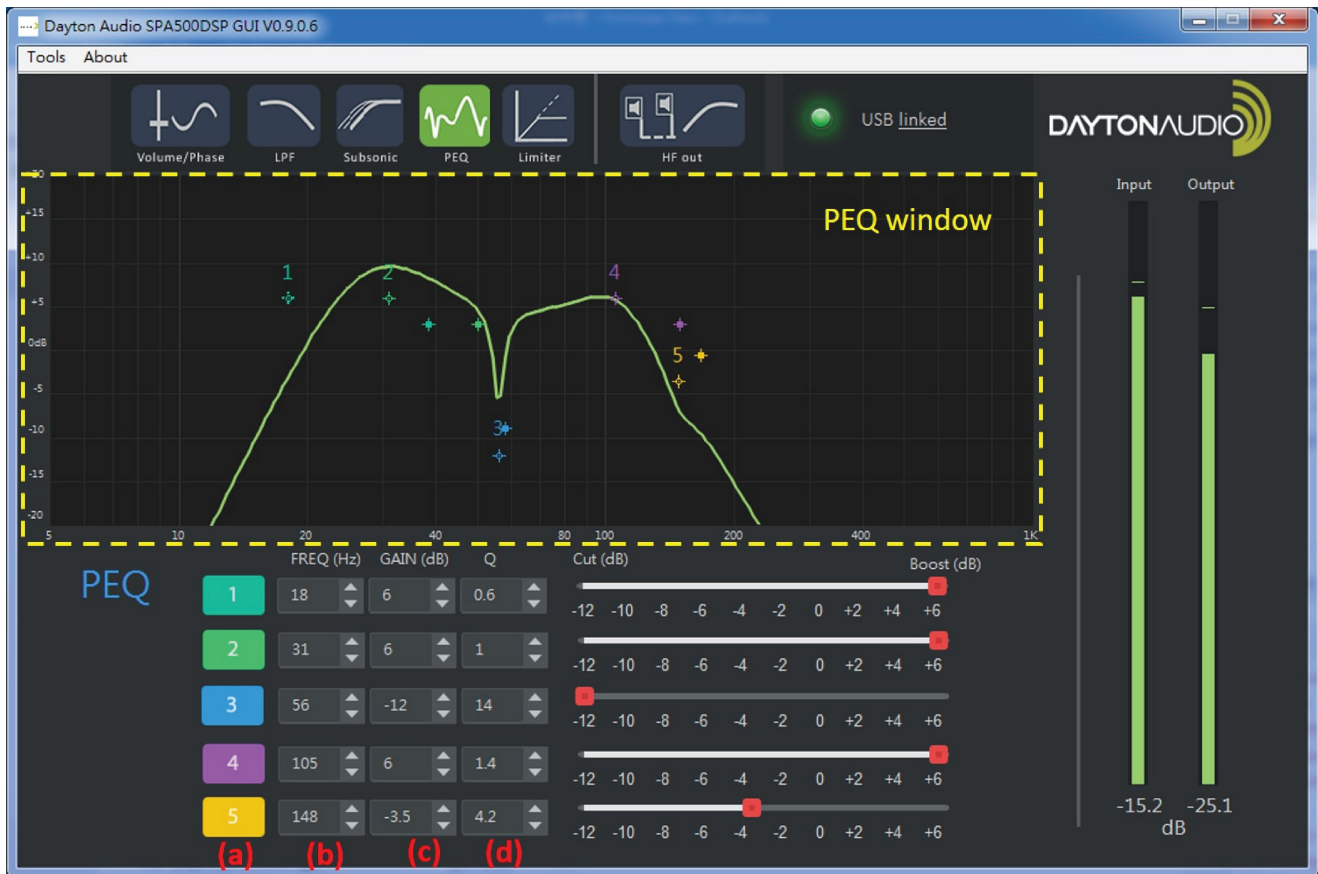

- **PEQ Window:** Graphical trace is NRT editable. Bands can be shaped by cursor or direct input and/or sliders
- **Detailed tool tips (shown a-d above):**
  - **5 Band-digital PEQ**
    - Band On/Off:** Bypass or enable by clicking the colorized 1~5 buttons
    - Center Frequency (CF):** Adjust Center Frequency of each EQ band, 10~200Hz, steps: 1Hz.
    - Gain:** Adjust the EQ gain (apparent volume), -12 ~ +6dB, steps: 0.1dB
    - Q (EQ width):** Adjust the "Q" value, 0.4~16 , step: 0.1

# Limiter

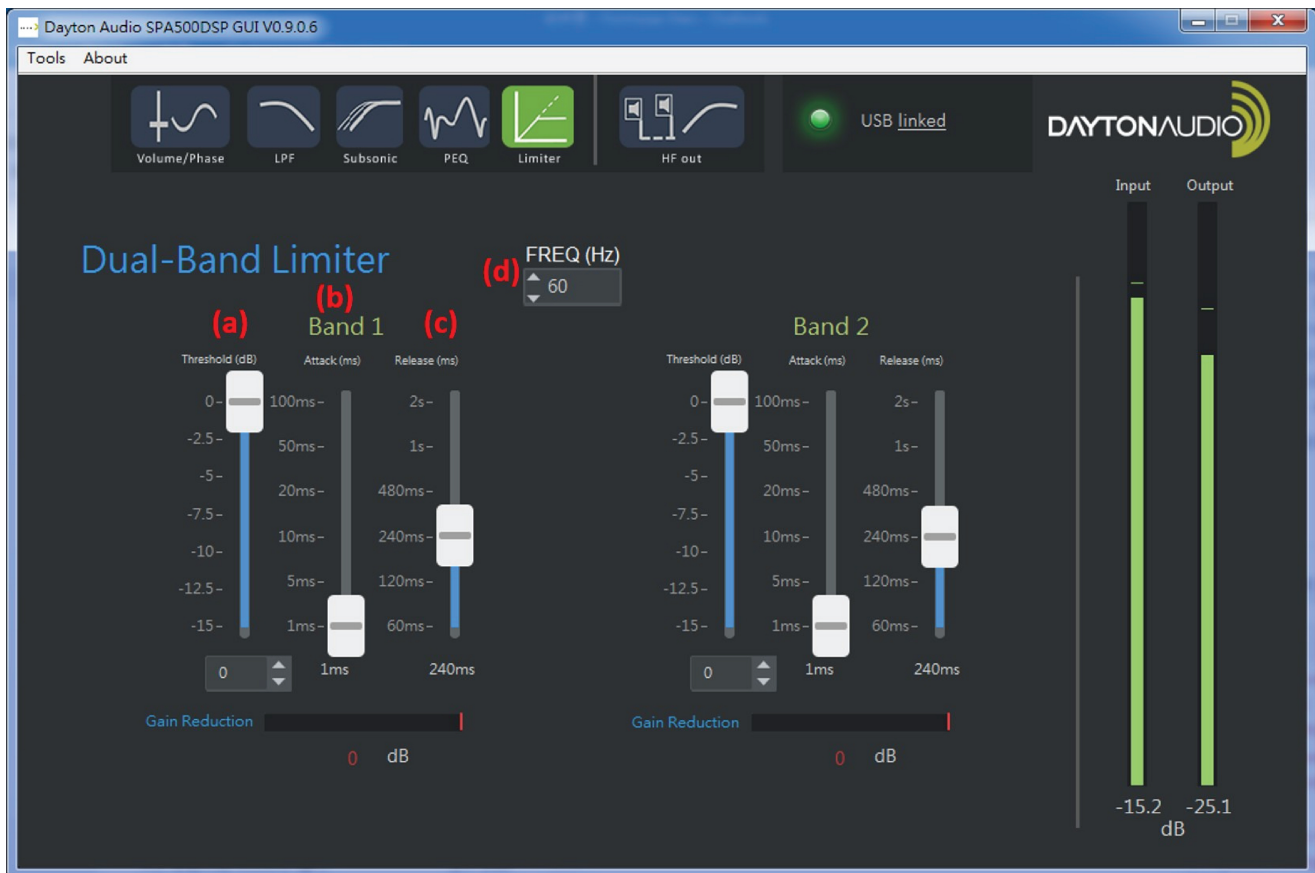

**Dual-Band Limiter:** Adjust, optimize, save, recall.

- Threshold:** Adjust the limiter threshold, 0~-12dB, step: 0.1dB
- Attack:** Adjust limiter's "attack time". This controls the time taken to attenuate signals over the threshold to the specified threshold level. Range: 1/5/10/20/100ms
- Release:** Adjust limiter's "release time". When signal is below threshold level, this controls the time taken to restore back to original level. Range: 60/120/240/480/1000/2000ms
- Frequency:** The crossover frequency point between the 2 bands: Band 1 (Low Frequency) & Band 2 (High Frequency).

# High Frequency Out



- This block controls the DSP parameters for line level output only.
- **Delay:** Adjust the time difference between High Frequency out and Subwoofer out.
- **HPF Control:**
  - **Filter ON/OFF:** Bypass or Enable the selected filter.
  - **Slope:** Select roll-off gradient of the selected filter: -12dB/-24dB per octave.
  - **Frequency:** Adjust cut-off frequency of the selected filter.

# Feature Menu display

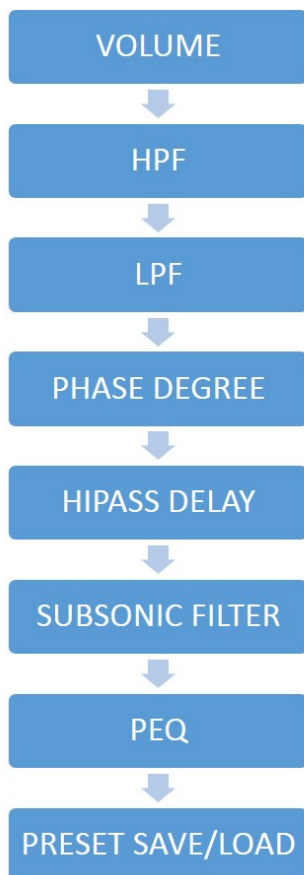

**Volume, Phase, Low-Pass Filters, and all other controls are also accessible via the included rotary control.**

Volume (shown above) is selected by a single click, upon which simple rotation allows 0.1dB adjustment. A “double-click” brings you back to the main menu. Subsequent rotation of the controller from the main menu navigates you through a series of setup menus.

Each of the “Function frames” at left correspond to the major feature controls on the amp. Each feature control uses the same single/double-click navigation. Note all detailed sub-features on the next page. Scroll around your amp and get familiar with its simple click and double-click feature rotation.

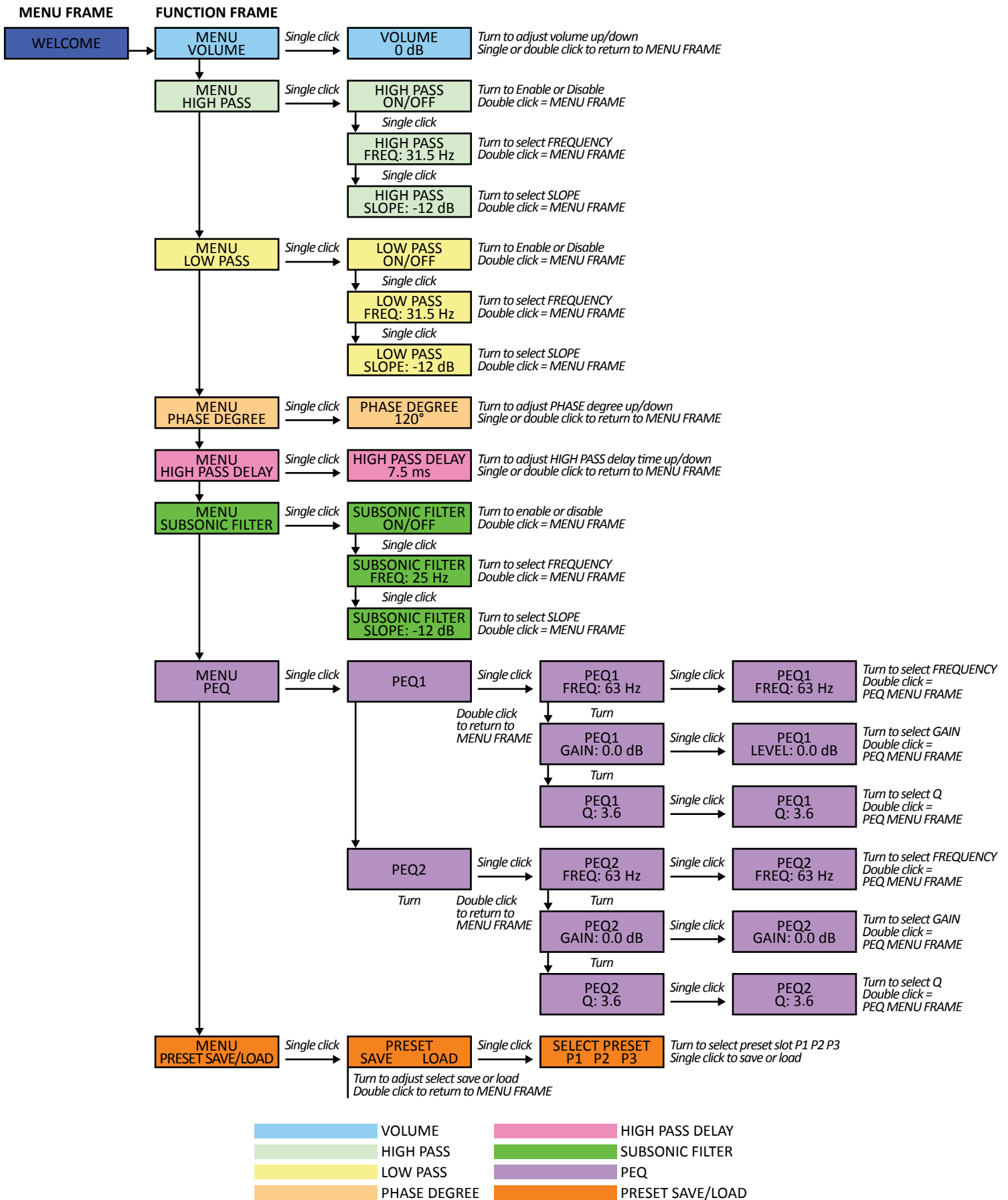

# DSP Functions

## Feature Controller (LCD matrix, single-knob)

1. **Volume Range:** 0dB ~ -99dB.(0.1dB/step)
2. **High pass Filter:** (line level output only)
  - **Frequency Range:** 30~125Hz (1Hz/step)
  - **Slope select:** Disabled/-12dB/-24dB
3. **High Pass Delay:** 0~10msec(0.1msec/step)
4. **Low pass Filter:** (subwoofer amp output only)
  - **Frequency Range:** 30~125Hz (1Hz/step)
  - **Slope select:** Disabled/-12dB/-24dB
5. **Variable Phase:** 0° ~ 180°(1°/step)
6. **Subsonic Filter:** (subwoofer amp output only)
  - **Frequency Range:** 25~40Hz (1Hz/step)
  - **Slope select:** Disabled/-12dB/-24dB
7. **P-EQ1/P-EQ2 adjustment:** (subwoofer amp output only)
  - **Frequency Range:** 30~125Hz (1Hz/step)
  - **Level Range:** -12dB ~ +6dB (0.1dB/step)
  - **Q Factor Range:** 0.6~14 (0.1/step)
8. **Preset Save/Load:** 3 Presets

## Advanced Control (for GUI via USB port, PC)

1. **I/O level meter (0 ~ -99dB)**
2. **5-Band Parametric EQ Settings**
  - **Frequency Range:** 10~200Hz (1Hz/step)
  - **Level Range:** -12dB ~ +6dB (0.1dB/step)
  - **Q Factor Range:** 0.6~14 (0.1/step)
3. **Limiter**
  - **Threshold Range:** -15dB ~ 0dB (0.1dB/step)
  - **Attack Time Range:** 1/5/10/20/50/100ms
  - **Release Time Range:** 60/120/240/480/1000/2000ms



# Base Specifications (Audio Precision®)

Parameters	Test conditions	Typical value
<b>Input sensitivity</b>	RCA IN 520W/4ohms @115VAC XLR IN 500W/4ohms @115VAC	-10dBV -10dBV
<b>Gain</b>	AMP output 100Hz @ 1W output	+43.0dB
<b>Input saturation level</b>	RCA left or right 100Hz XLR left or right 100Hz	>2V(Hi-Level IN) >2V(Hi-Level IN)
<b>Noise Level</b>	volume=0dB (MAX)@A weighted	-62.3dBV (S/N Ratio 98.4dB)
<b>THD+N Ratio</b>	20-20kHz Filter, Rated Power @100Hz	< 1%
<b>Output power (4Ω)</b>	100Hz@115VAC, Input: -10dBV (L+R)	500 W
<b>Auto ON/OFF</b> Auto ON sensitivity Auto OFF time	RCA Left ,100Hz	3mV 20mins
<b>Time delay</b>		2ms
<b>Power amplifier Protection</b>	A- Short-circuit and under load protection B- Thermal protection C-Power Supply Protection-Full Power Protection	A-Yes B-Yes C-Yes
<b>Power Consumption:</b>	@230Vac/60Hz A- Standby mode @230Vac/60Hz B- ON mode @230Vac/60Hz C- Rated power @115Vac/60Hz A- Standby mode @115Vac/60Hz B- ON mode @115Vac/60Hz C- Rated power	A- 0.50 W B- 7.50 W C- 561 W A- 0.42 W B- 7.50 W C- 569 W

SPA500DSP	
<b>Weight:</b>	1.1kG
<b>Dimension:</b>	262 (H) x 184 (W) x 60 (D) mm

**5-Year Limited Warranty**  
See [daytonaudio.com](http://daytonaudio.com) for details



**daytonaudio.com**  
tel + 937.743.8248  
[info@daytonaudio.com](mailto:info@daytonaudio.com)

705 Pleasant Valley Dr.  
Springboro, OH 45066  
USA



Dayton Audio®

Last Revised: 7/13/2017